



Model 1900 Maintenance Instructions

Rod Connector Secured
with a Shoulder Screw

For Pump Revision: C

BISON PUMPS
The Power of Water in Your Hands

Rev C-1

Table of Contents

Maintenance Instructions

1. Handle Disassembly	5
2. Top Plate/Rod Assembly removal from Cylinder Body and separation	5
3. Top Plate Disassembly.....	6
4. Rod/Piston Cup Disassembly.....	6
5. Lower Check Valve Disassembly	7
6. Bottom Plate Reassembly	8
7. Pump Body Installation	8
8. Rod/Piston Cup Assembly	9
9. Top Plate/Lift Rod Assembly	10
10. Handle Reassembly.....	11
11. Mechanical Assembly Installation onto Pump Body.....	11
12. Test the Pump.....	11

Appendix

Detail A: Exploded View	13
Detail B: Part Listing	14

- ⚠ Caution: Failure to carefully follow procedures may result in property damage and serious injury.
- ⚠ Caution: The following personal protective equipment is recommended during all maintenance operations:
 - Safety Glasses

Recommended Tool List:

1. Two (2) 9/16" Box Wrenches
2. One (1) 5/32" Allen Wrench
3. One (1) Flathead Screwdriver with small tip (1/4")
4. One (1) 3/16" Allen Wrench
5. One (1) 1/2" Box Wrench
6. One (1) Bench Vice
7. One (1) 1/8" Allen Wrench
8. One (1) 16 oz. Hammer
9. One (1) 5/32" Drift Punch
10. 12"x12" Clean Cotton Rag
11. One (1) Pair of Safety Goggles or Glasses
12. One (1) Internal Snap Ring Pliers, .070"-.078" Tip – Available for Purchase
13. One (1) Can Extra Virgin Olive Oil
14. One (1) O-Ring Pick Tool – Included in Kit
15. One (1) Adjustable Pipe Wrench (18")
16. One (1) Roll Teflon Tape – Available for Purchase
17. One (1) Long Screwdriver or Dowel (16")

Closest matching Metric sizes may also be used



BISON PUMPS
The Power of Water in Your Hands

Contents of Maintenance Kit:

55-001-3-04-01

Part Description	Quantity	Bison Part Number
Top Plate:		
1. Securing Top Plate		
a. Custom Low-Profile Internal Hex Fastener	1	50-001-0-08-02
2. Internal Top Plate Components		
a. Packing Gland Nut	1	50-100-0-07-00
b. Backing Washer, Nylon 5/8" OD	1	04-000-5-40-02
c. Packing Gland Cup Seal 0.5" ID	1	04-001-3-71-01
d. Bottom Bushing	1	50-100-0-08-05
3. External Top Plate Component		
a. O-Ring Buna	1	04-139-3-70-02
Piston Assembly/Pump Body:		
4. Securing Rod Connector		
a. Shoulder Screw 316 Stainless Steel	1	50-001-0-04-05
5. Check Valve	2	04-000-5-75-01
6. Internal Snap Ring, Stainless Steel	2	04-022-1-68-01
7. Piston Cup Seal	2	04-002-3-71-01
Handle:		
8. Link Washer, Nylon 3/8" OD	12	04-000-5-40-01
9. Ny-Loc Nut, Link Connection	2	04-000-1-50-20
10. Ny-Loc Nut, Shoulder Bolt	1	04-000-1-50-19
Tools:		
11. O-Ring Pick Tool	1	55-001-0-07-00

See Details A & B for an exploded view and a full part listing of the pump components.



THE POWER OF FORCE IN YOUR HANDS

1) Handle Disassembly:

- Use two 9/16" wrenches to turn the Ny-loc nuts counter-clockwise to loosen and remove them from the bolts as shown below. Discard the used Ny-loc nuts as they will be replaced. A 3/16" Allen wrench should be used in place of one of the 9/16" wrenches if shoulder bolts are present.
- Remove the two bolts from the assembly and set aside for reassembly, along with the Links. Discard the used Link Washers as they will be replaced.
- Use a 3/16" Allen wrench and a 1/2" wrench to loosen and remove the Ny-loc nut from the shoulder bolt.
- Remove the bolt from the assembly. Separate the handle from the lift rod and set aside for later reassembly.



Figure 1

2) Top Plate/Rod Assembly removal from Cylinder Body and separation:

- Use a 5/32" Allen wrench or flat head screwdriver (1/4" tip) to loosen and remove the 4 fasteners attaching the top plate to the cylinder body, in a counter-clockwise direction, as shown in **Figure 2**. Set aside fasteners for reinstallation. There is 1 spare screw in the maintenance kit.
- Carefully lift the top plate and Piston Assembly to separate it from the Pump Body. This should require minimum force to remove.



Figure 2



- Remove the shoulder screw from the Rod Connector using a 1/8" Allen wrench, as shown in **Figure 3**.
- Separate the Rod Connector from the Rod.
- Separate the Rod from the top plate.

Figure 3

3) Top Plate Disassembly:

- a. Use your hand, loosen and remove the Gland Nut by turning it counter-clockwise, as shown in **Figure 4**. Discard the used Gland Nut. There is a replacement component, located in the maintenance kit.

Note: If you cannot loosen the Gland Nut by hand, use a 1-1/8" open end wrench or a pair of pliers to lightly apply pressure in the counter-clockwise direction until the Gland Nut beaks loose. Then run the Gland Nut out by hand and remove.



Figure 4



Figure 5

- b. Use the O-ring Pick provided in the maintenance kit to remove the Packing Gland Cup Seal, Backing Washer and Bottom Bushing, as shown in **Figure 5**. Discard all removed components. There is a replacement for each, located in the maintenance kit.



Figure 6

4) Rod/Piston Cup Disassembly:

- a. Fold a 12"x12" Cloth Rag in half and wrap it around the Lift Rod. Use a vice to secure the Rod in a position that allows access to the snap ring inside the bottom of the Piston Cup, retaining the check valve, as shown in **Figure 6**.

Note: Clamp the Rod in the vice with enough force to hold it in position securely, but not so much as to damage or mar the surface of the Rod.

- b. Use the O-ring Pick Tool to remove two Piston Cup Seals from the outer surface of the piston. Discard both gaskets, they will be replaced using new components from the maintenance kit.

- c. Use the Internal Snap Ring Pliers to remove the Internal Snap Ring by inserting the tip of the pliers into the two holes, squeezing them together, and lifting the ring out of the cavity, as shown in **Figure 7**. Discard the Snap Ring, it will be replaced with a new component from the maintenance kit.



Figure 7

- d. Use a Flat Head Screwdriver, push the Check Valve out of the cavity as shown in **Figure 8**. Take care not to damage the wall of the cavity or ring groove. Discard the Check Valve, it will be replaced with a new component in the maintenance kit.



Figure 8

- e. Thoroughly clean the Piston and Lift Rod with fresh water, paying close attention to the Check Valve Cavity, Internal Snap Ring groove and Cup Seal grooves.

5) Lower Check Valve Disassembly:

- a. The Lower Check Valve typically is not a maintenance issue. In the event the pump is losing its prime, there is likely a malfunction with the Lower Check Valve.

Note: Due to the arduous maintenance process involved with replacing the Lower Check Valve, it is ill-advised to change this component if it is in good working order. In the event there is a malfunction, continue using the steps below.

- b. Use a corresponding size box wrench or socket to loosen and remove the 4 Ny-Loc Nuts from the mounting bolts in the base. This will allow access to the water source connection. Set all components aside, as they will be reinstalled.
- c. Use an 18" adjustable pipe wrench to disconnect the water source from the pump. Turn the wrench to loosen the nut, taking care not to over-torque or damage the pump or water source line components. If you are looking down on the wrench from above the pump, it will turn in a clockwise direction to loosen the fitting.

Note: If a reducer bushing is used in the connection, it will need to be removed to gain full access to the Lower Check Valve.

- d. With the unit disconnected from the water source line, turn the pump over in order to gain access to the Check Valve. Use the Internal Snap Ring Pliers to remove the Snap Ring from the base. Squeeze the pliers together to compress the ring, then pull the ring from the cavity.
- e. Use a 16" long screwdriver (or a ¼" – ½" diameter metal rod) to unseat and remove the Lower Check Valve. Insert the tool into the top of the Pump Body and place the tip on the top of the check valve as shown in **Figure 10**.
- f. Use the palm of your hand or a small 12oz. hammer to lightly tap the Check Valve until it is removed from the cavity. Take care not to damage the wall of the cavity or the ring groove. Discard the used Check Valve as it will be replaced by a new valve from the maintenance kit.



Figure 10

6) Bottom Plate Reassembly:

- a. Visually inspect the cavity, the pump cylinder and the new components to be assembled. Ensure all parts are free of damage, contamination and mechanical malfunction. Depress the check valve to ensure proper functionality and smooth motion. Clean Parts if necessary.
- b. Coat the outer body of the Check Valve with Extra Virgin Olive Oil. It is very important that the Check Valve is inserted into the bottom of the cavity with the correct orientation. The "Bullet" end should be inserted first into the cavity.



Figure 12

- c. Use a flat head screwdriver to depress all 4 plastic tabs on the Check Valve center rim as shown in **Figure 11**. Press the Check Valve into the cavity of the Piston, "Bullet" end first (**Figure 11**), until the Check Valve is seated and clears the Snap Ring Groove. If any part of the Groove is covered by the Check Valve, it is not properly seated and requires more force to properly seat it, *see Figure 12*.
- d. Use Snap Ring Pliers to insert the Snap Ring into the Groove.
- e. Ensure proper functionality and full range of motion in the Check Valve and proper seating of the Snap Ring.

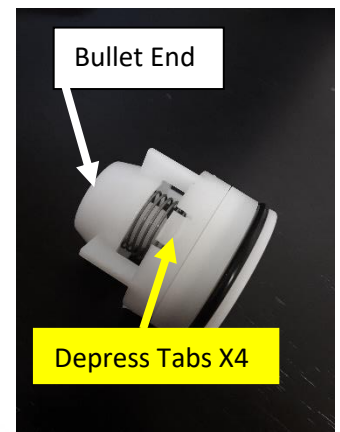

Figure 11

7) Pump Body Installation:

- a. Visually inspect the threaded connection areas of the Pump Body and the Water Source Line for damage and cleanliness. Clean parts if necessary.
- b. Wrap fresh Teflon tape around the reducer bushing (if one is needed) and thread it into the bottom of the Pump Body water inlet (where the water source attaches to the pump).
- c. Wrap fresh Teflon tape around the threads of the Water Source Line. Set the Pump Body over the Water Source Line, aligning the mating connection. Thread the Pump Body onto the Water Source by turning it Clockwise. Tighten the connection with a Pipe Wrench in the Clockwise Direction.
- d. Align the Pump Body so that the 4 attachment bolts in the Base Plate align with their original mount holes.
- e. Install the 4 Carriage Bolts through the base plate and mounting surface. Use a corresponding size box wrench or socket to install 4 Flat Washers and 4 Nuts onto the Carriage Bolts. Thread the nuts in a clockwise direction until they are tight.

8) **Rod/Piston Cup Assembly:**

- a. Visually inspect the Piston Cup, Rod and components for damage and cleanliness. Clean parts if necessary.
- b. Coat the outer body of the Check Valve with Extra Virgin Olive Oil. It is very important that the Check Valve is inserted into the piston with the correct Flow Orientation, "Bullet" end first, similar to the Lower Check Valve Installation *see Figure 11*.
- c. Use a flat head screwdriver to depress all 4 plastic tabs on the Check Valve center rim as shown in *Figure 11*.
- d. Press the Check Valve into the cavity of the Piston, "Bullet" end first (*Figure 11*), until the Check Valve is seated and clears the Snap Ring Groove. If any part of the Groove is covered by the Check Valve, it is not properly seated and requires more force to properly seat it, *see Figure 12*.
- e. Use Snap Ring Pliers to insert the Snap Ring into the Groove. *See Figure 16*.
- f. Ensure proper functionality and full range of motion in the Check Valve and proper seating of the Snap Ring.
- g. Install 2 new Piston Cup Seals onto the Piston Cup using your hands to work the Seals over the cups radial surface. Make sure the "Cup" Side of both Cup Seals is facing towards the Piston Lift Rod as shown in *Figure 17 and 17.1*.



Figure 16

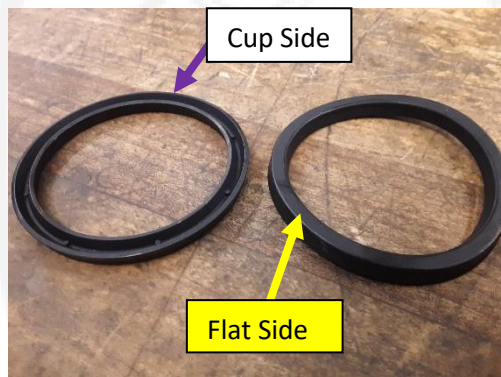

Figure 17.1

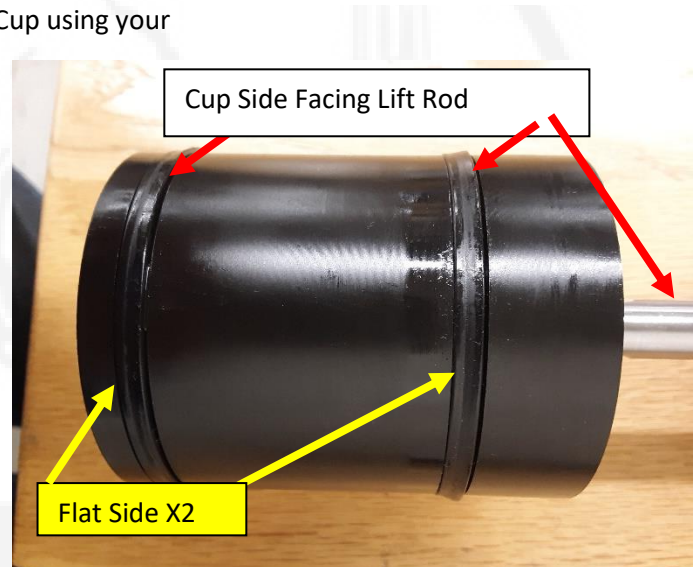

Figure 17

BISON PUMPS
The Power of Water in Your Hands

9) Top Plate/Lift Rod Assembly:

- a. Visually inspect the Lift Rod Assembly, Top Plate and all new components for damage and cleanliness prior to assembly. Clean parts if necessary.
- b. Insert the Piston/Lift Rod Assembly into the Top Plate with the Rod protruding through the top surface of the Top Plate. As shown in Figure 18.
- c. Install the Bottom Step Bushing onto the rod and into the threaded cavity of the Top Plate. The smaller Radial Diameter should be down or first when inserting into the cavity. The Bushing should seat into the cavity and the lower surface should be flush with the lower surface of the Top Plate. See **Figure 18. Reference: Figure 18.1**
- d. Install the Seal onto the rod, with the Cup Side down towards the Top Plate. Run the seal down to mate with the cavity in the Top Plate as shown in **Figure 19**.
- e. Use your fingers or the Pick Tool to work the Seal into the cavity until the upper surface of the Seal is flush with the upper surface of the Top Plate as shown in **Figure 20**. (Lubricating the seal may help this process.)



Figure 18

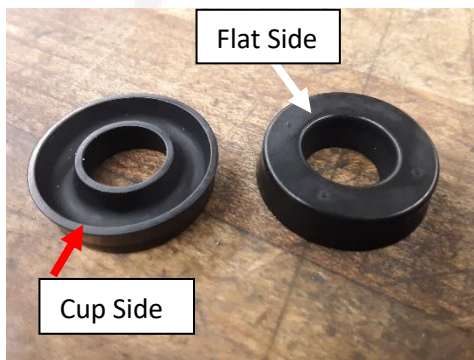

Figure 18.1



Figure 19



Figure 20

- f. Install the Nylon Backing Washer onto the Lift Rod, in any orientation.
- g. Install the Packing Gland Nut onto the Lift Rod with the threaded side down. Push the Gland Nut into the Top Plate cavity and turn clockwise using your fingers until the threads engage. Once the threads engage, turn the Nut two full revolutions in a clockwise direction. (After installation, this Gland Nut might need to be tightened slightly if it is leaking. Over time the seal could lose elasticity and may require this nut to be tightened. This will only be necessary if this seal is leaking water during normal use of the Bison Pump.)

10) Handle Reassembly:

- a. Visually inspect all of the components for damage and cleanliness prior to assembly. Clean parts if necessary.
- b. Place the Rod Connector in the vice with one of the holes facing up. Insert the Lift Rod into the Rod Connector so that the mating holes line up flush. Insert the new Shoulder Screw into the hole through the Rod Connector and Lift Rod. Use a 1/8" Allen Wrench to thread shoulder screw in a clockwise direction until it is flush with the outer surface of the Rod Connector as shown in **Figure 21**.
- c. Slide the Handle over the rod connector so that the mating holes are aligned. Insert the shoulder bolt into the Handle, protruding all the way through to the opposite side of the handle. Finger tighten the Ny-Loc Nut onto the Shoulder Bolt.
- d. Use a 3/16" Allen Wrench and 1/2" Box Wrench or Socket to tighten the Ny-Loc Nut onto the Shoulder Bolt in a clockwise direction until snug. **Make sure to not over torque this nut as it creates a friction point making pumping more strenuous.**
- e. Use two 9/16" Box Wrenches or Sockets to install the 3 Handle Links, 8 Link Washers (for hex bolts) or 12 Link Washer (for shoulder bolts), 2 Bolts and 2 Ny-loc Nuts onto the Handle and Top Plate flange, **see Figure 22**.
- f. Tighten the nuts in a clockwise direction using both wrenches and/or sockets. **Make sure to not over torque this nut as it creates a friction point making pumping more strenuous. It should not take a high amount of force to operate the pump. If the handle is hard to move, loosen the nuts slightly until the pump operates smoothly and with ease.**



Figure 21

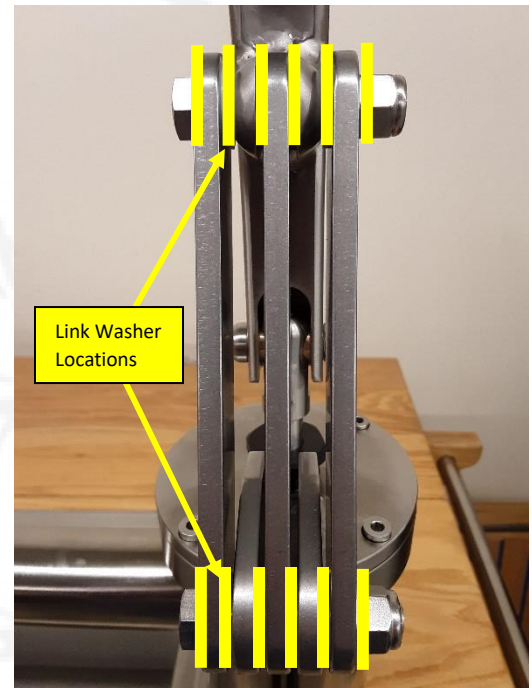

Figure 22

11) Mechanical Assembly Installation onto Pump Body

- a. At this point the entire Pump System should be in two assemblies and 4 bolts used to attach the Mechanical Assembly to the Pump Body.
- b. **Inspect the Piston and Pump Body for damage and cleanliness prior to installation.**
- c. Lubricate the inside of the Pump Body and the Piston Cup Seals with Extra Virgin Olive Oil.
- d. Insert the Mechanical Assembly onto the Pump Body and align the mounting holes in the Top Plate with the holes in the Top Ring.
- e. Use a 5/32" Allen Wrench to thread the bolts in a clockwise direction until they are tight.

12) Test the Pump:

- a. Grasp the handle and pull up and down. Listen for the "Burp" sound of the Check Valves. As the handle is pulled upward the bottom Check Valve should make a "Burping" sound. When the handle is pushed downward, the Piston Check Valve should make a "Burping" sound.
- b. As mentioned in "Step 11.g.", if the Packing Gland Nut is leaking, tighten 1/4 turn until it stops.

For Technical Help call our Toll-Free Number at 1(800)339-2601.

Appendix

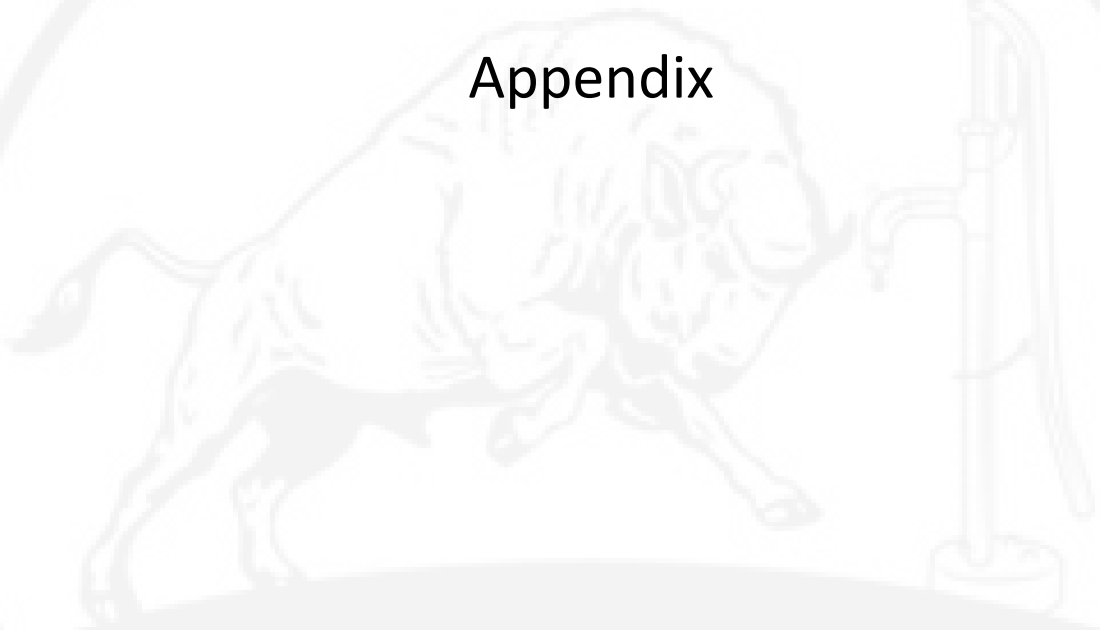

BISON PUMPS
The Power of Water in Your Hands

Detail A: Exploded View

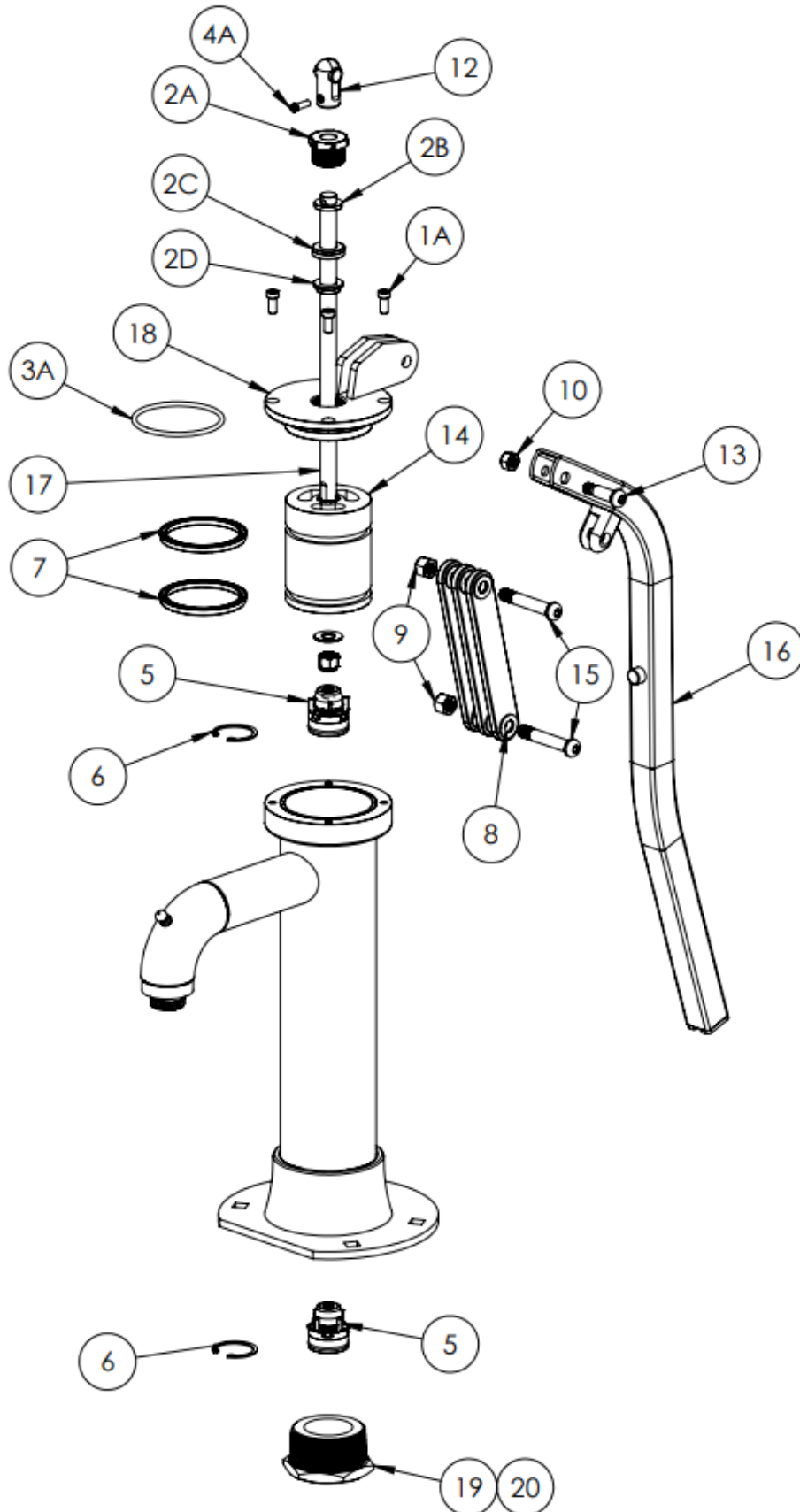

Detail B: Part Listing

Item No.	Part Number	Description	Quantity
1A	50-001-0-08-02	Custom Low-Profile Fastener	4
2A	50-100-0-07-00	Gland Nut	1
2B	04-000-5-40-02	Packing Gland Backing Washer	1
2C	04-001-3-71-01	Packing Gland Cup Seal	1
2D	50-100-0-08-05	Bottom Bushing	1
3A	04-139-3-70-02	Top Plate O-Ring	1
4A	50-001-0-04-05	Rod Connector Shoulder Screw	1
5	04-000-5-75-01	Check Valve	2
6	04-022-1-68-01	Internal Snap Ring	2
7	04-002-3-71-01	Piston Cup Seal	2
8	04-000-5-40-01	Link Washer	12
9	04-000-1-50-20	Link Ny-Loc Nut	2
10	04-000-1-50-19	Shoulder Bolt Ny-Loc Nut	1
11	55-001-0-07-00	O-ring Pick Tool	1
12	50-001-0-04-04	Rod Connector	1
13	50-001-0-03-06	Handle Shoulder Bolt	1
14	50-001-0-04-02	Piston	1
15	50-001-9-03-10	Link Shoulder/Hex Bolt	2
16	50-001-0-03-01	Handle Assembly	1
17	50-001-0-04-03	Lift Rod	1
18	50-001-0-06-02	Top Plate	1
19	04-029-0-74-01	Reducer Bushing (2" to 1 ¼") (Std.)	1
20	04-029-0-74-02	Reducer Bushing (2" to 1") (Opt.)	1